

AS U294 surface mounted watertight profile is specially designed for places with vehicular traffic and water leakage risk. Load bearing capacity can be adjusted from cars to heavy trucks by changing the metal cover. Specially designed elastomeric gasket provides high movement ability and excellent resistance to UV radiation, ozone, de-icing salts and chemicals. Chamfered design ensures a smooth transition.

- Application Areas** : Indoor & Outdoor / Floor
- Ideal for** : Car Parks, Factories, Warehouses, etc.
- Material** : Mill Finish Aluminum (Anodizing optional), Stainless Steel (Optional), EPDM Rubber
- Aluminum Alloy** : 6063 AA-USA / EN AW 6063
- Optional Supplies** : Fire Barrier

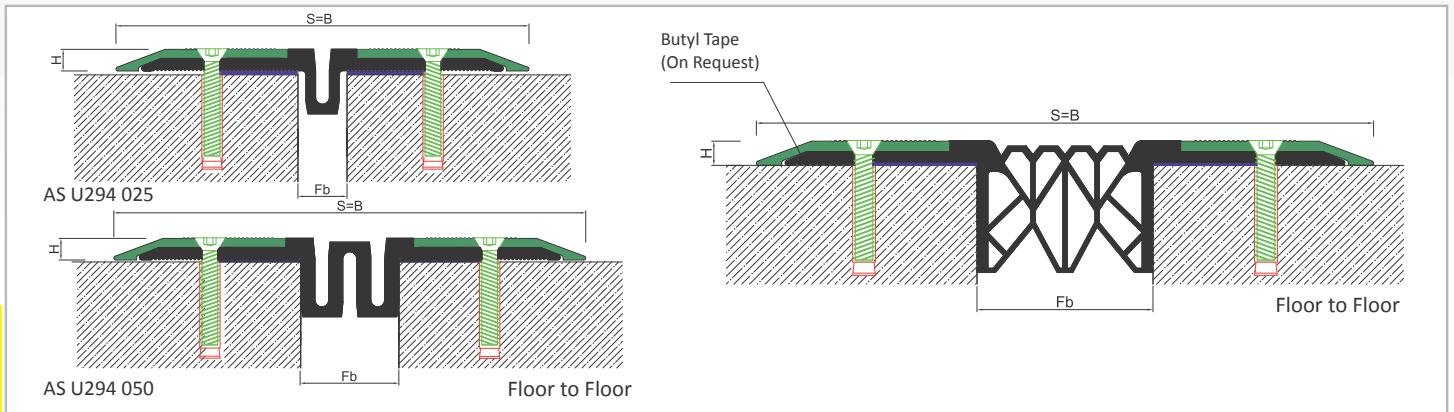
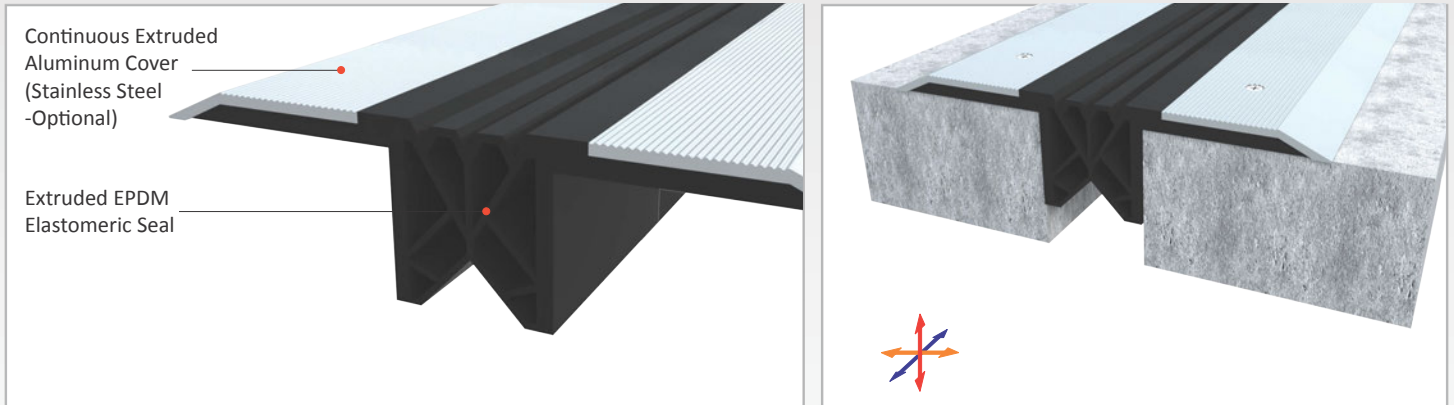

* Visuals are representative and the profile configuration may differ depending on the characteristics requested.

WATERTIGHT FLOOR

RUBBER COLOR **BLACK**

LOCATION	MODEL	GAP (Fb) mm	HEIGHT (H) MM	OVERALL WIDTH (B) mm	VISIBLE WIDTH (S) mm	MOVEMENT (W) mm	LOAD CAPACITY	STANDARD LENGTH (mt)
Floor to Floor	AS U294-025	25	11	210	210	±8	35 kN 300 kN	3
	AS U294-050	50	11	240	240	±20	35 kN 300 kN	3
	AS U294-080	80	11	280	280	±20	35 kN 300 kN	3
	AS U294-100	100	11	300	300	±25		3

Note: Please ask for different sizes
 Minimum order quantity will be applied if the inquired quantity is not available in stock



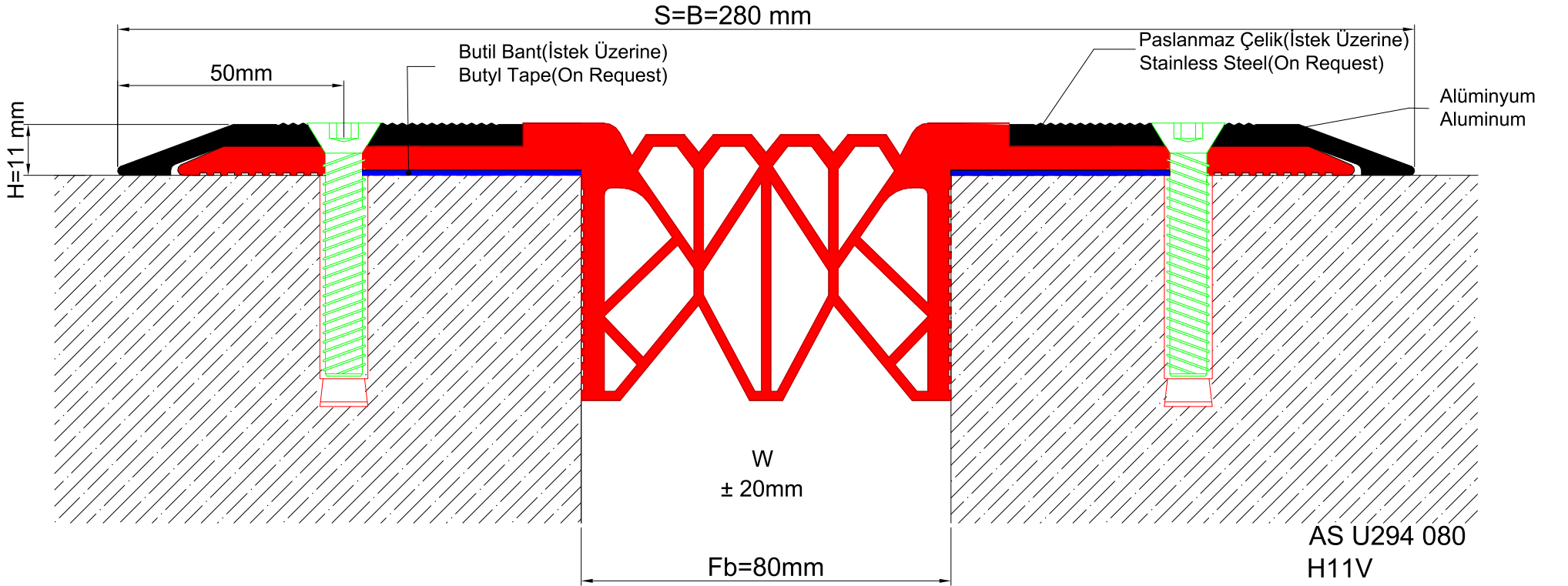

Profil No Profile Number		AS U294 080
Fb (mm)		80
H (mm)	yaklaşık approx.	11
W± (mm)	yaklaşık approx.	± 20mm
Renk Color		Alüminyum: Natürel, Fitiller: Siyah Aluminum: Natural, Inserts: Black
Malzeme Material		Alüminyum, EPDM Kauçuk (siyah) Aluminum, EPDM Rubber (black)
Standart Uzunluk Standard Length		3
Yükleme Kapasitesi Load-bearing Capacity		35 kN  300kN 